



CONSTRUCT-A-PUZZLE PAPERCRAFT KIT

FREE PUZZLE

Cut out, fold and stick!
In this exclusive sneak peek,
construct a game room from the world of **The Last Pyramid!**

Once you have built it, **it's time to solve the challenge within!**

PLUS! Play again with extra printable parts!

YOUR CHALLENGE



GAME 1: CHEMICAL CROSSWORD	
PARTS	2-8
INSTRUCTIONS	9-11
EXTRA PARTS	12-13
SOLUTIONS	14

Red pages are pages that you need to print.
Grey pages are your instructions!

Parts pages include cut & fold guides.

Completed games measure up to **26 x 20 x 17cm!**

You will also need:
Glue Stick
Scissors

For best results
print onto heavyweight paper
or card for a more sturdy creation!



B

RIGHT WALL

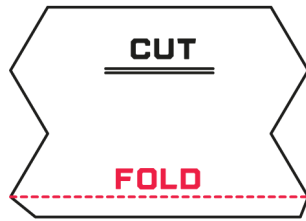

C LEFT WALL

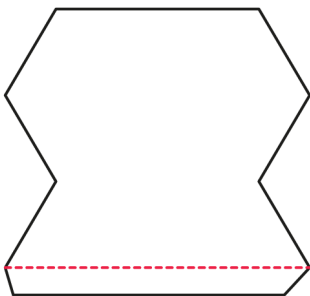
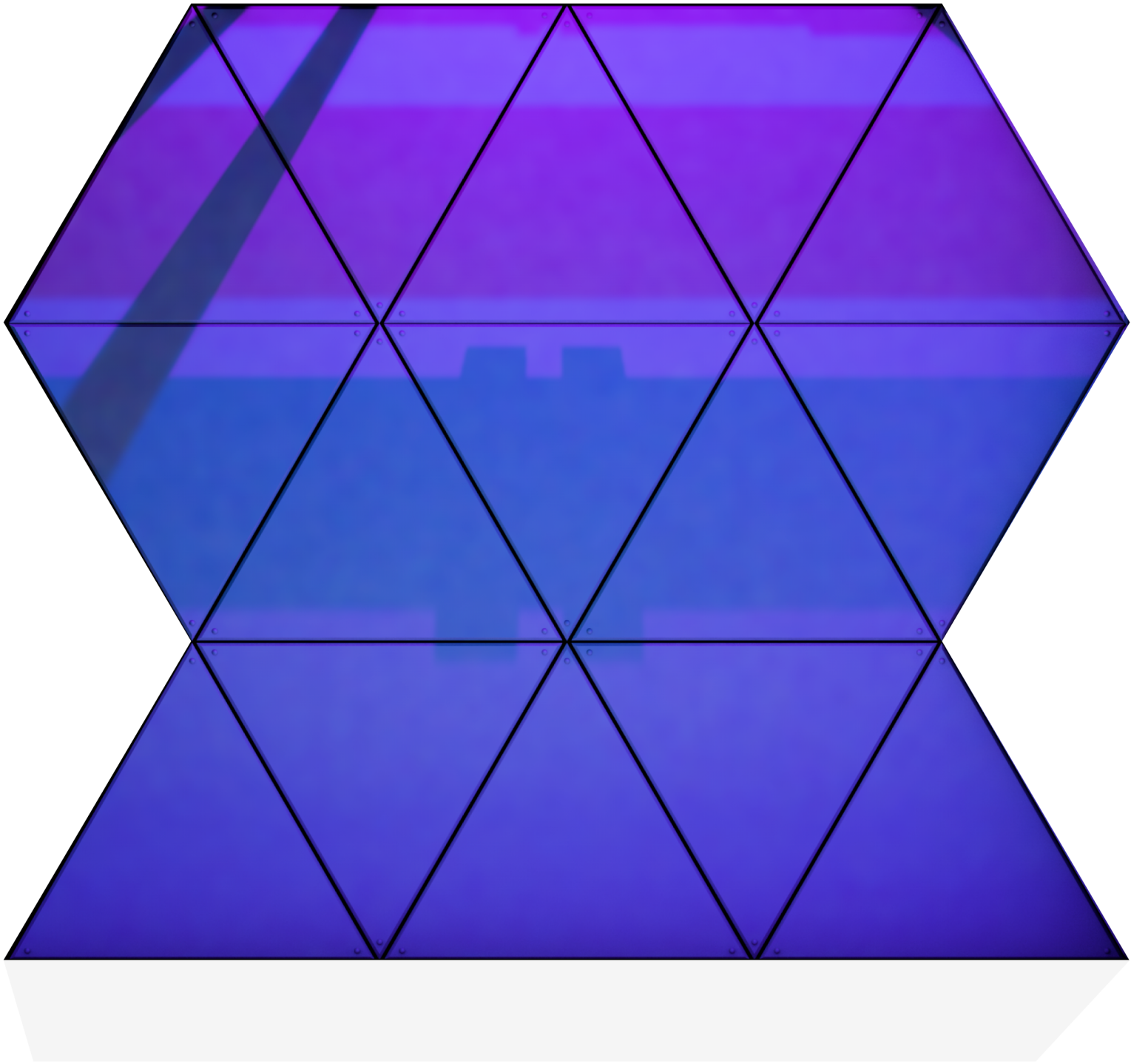

D NEON TUBE



E CORNER (TOP)

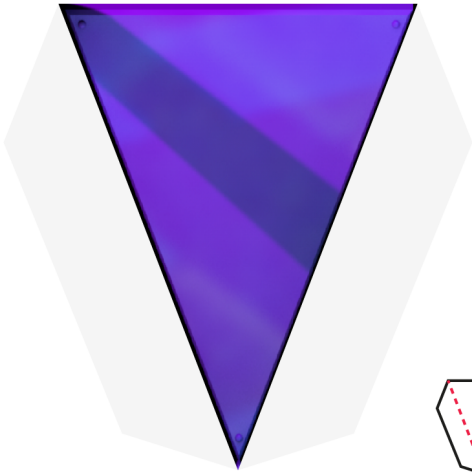

F CORNER (BOTTOM)

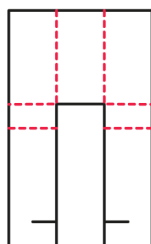
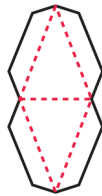
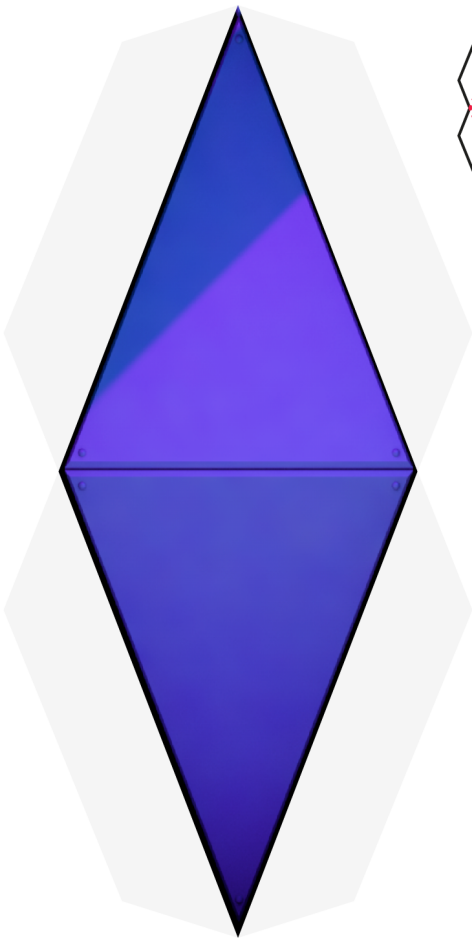

G FEET (x8)

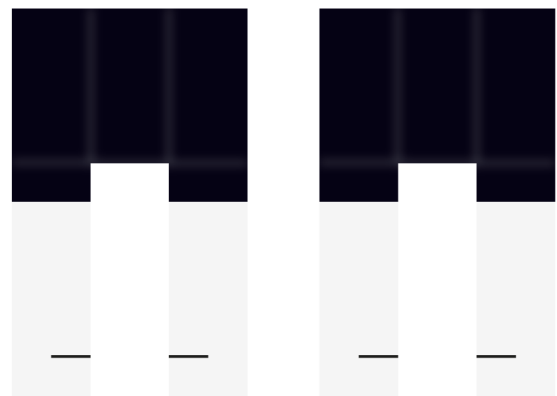
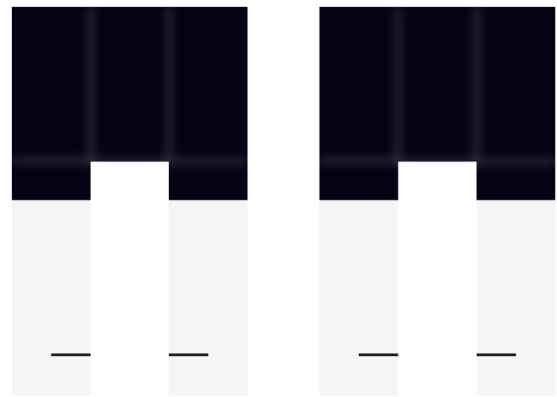
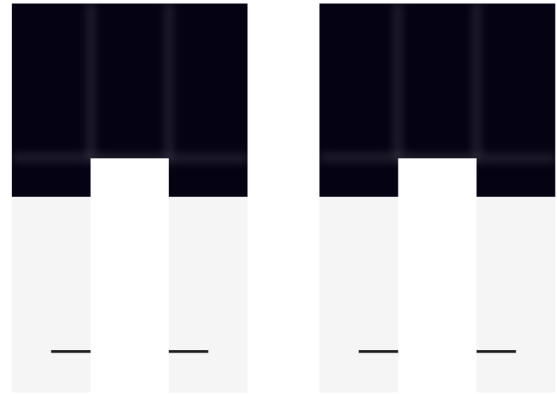

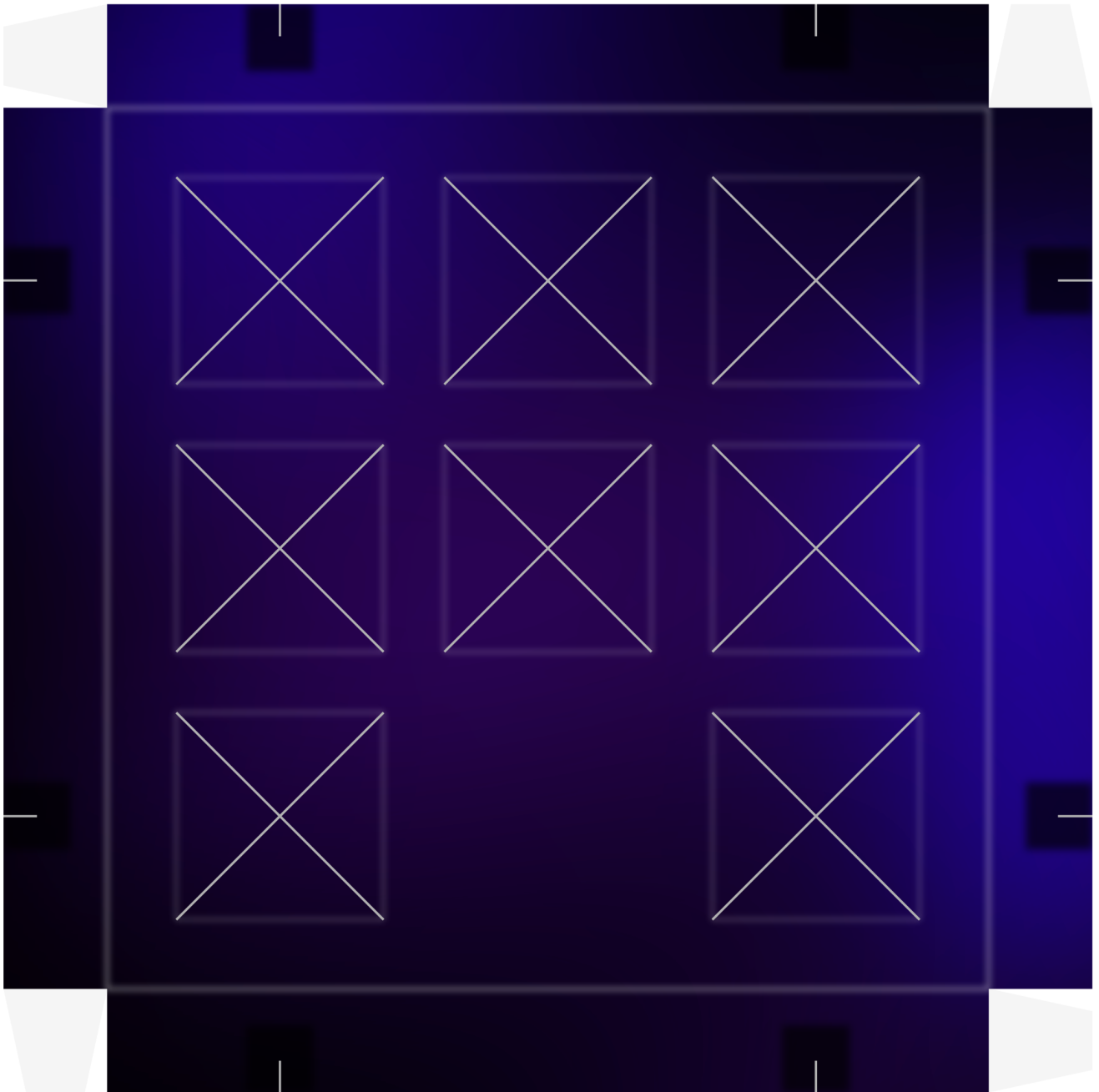

H TABLE

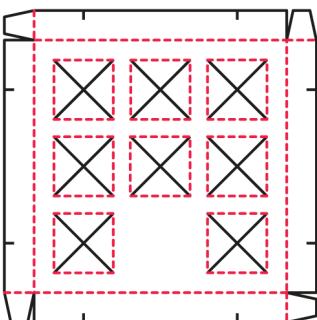

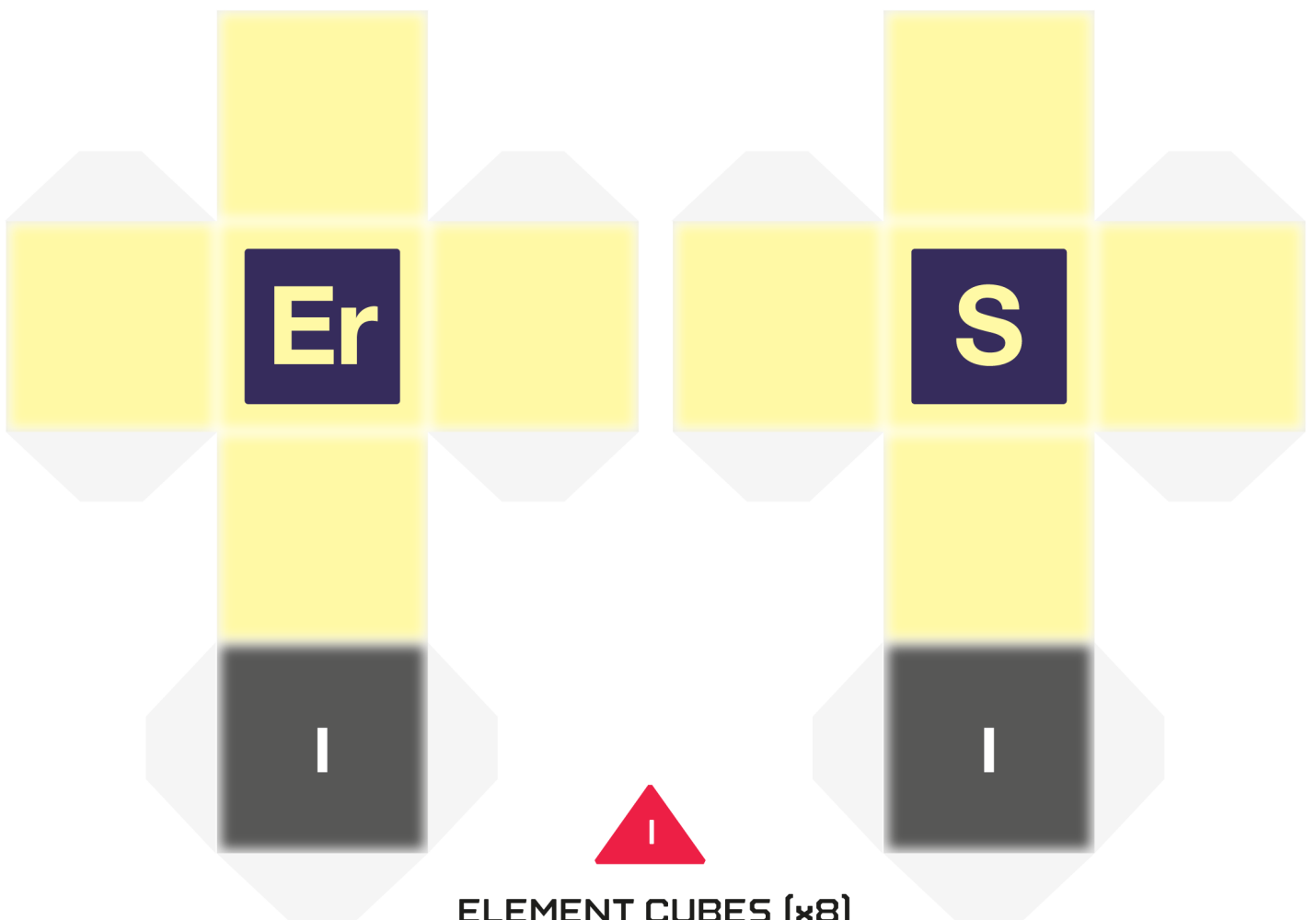
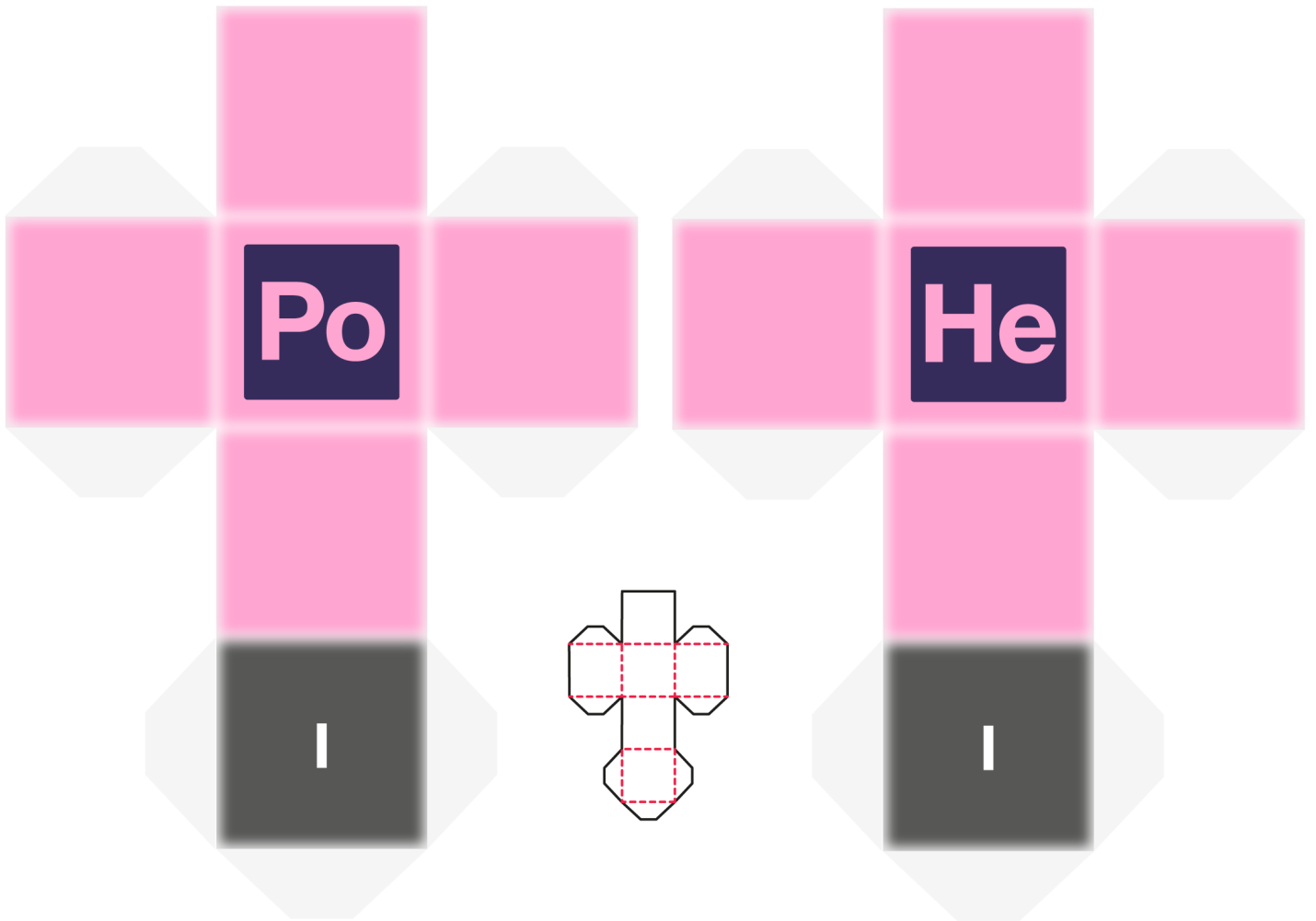

ELEMENT CUBES (x8)

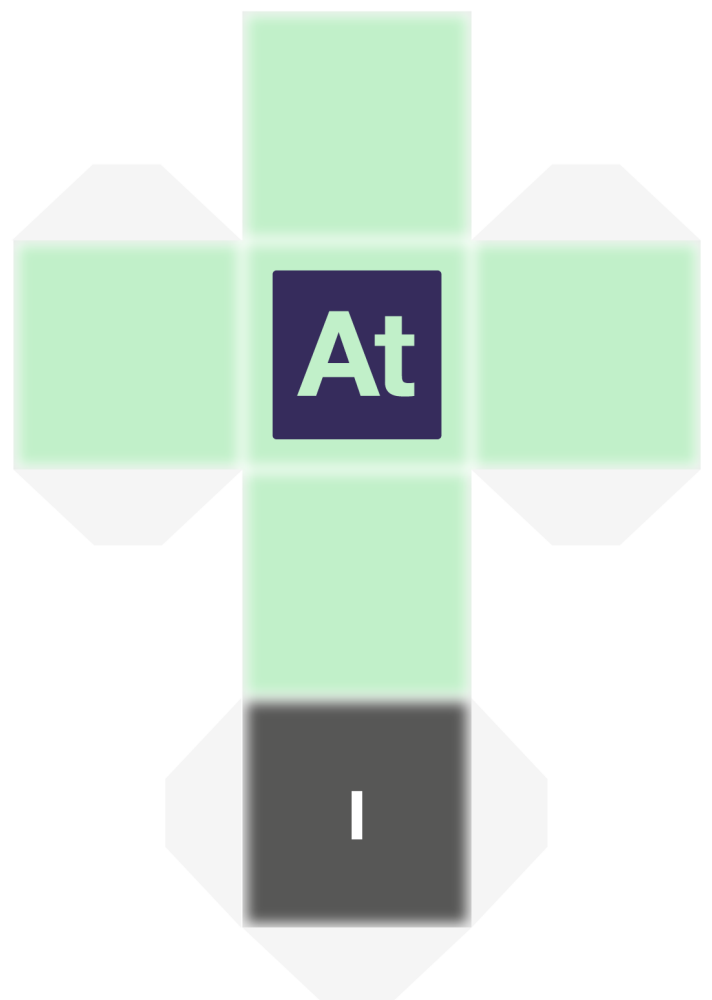
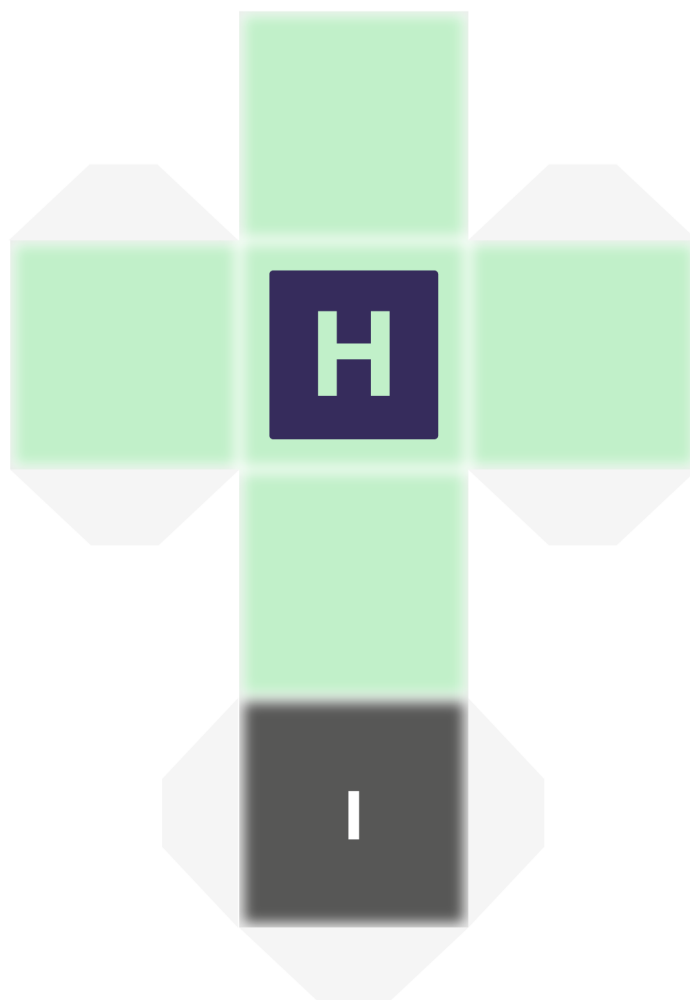
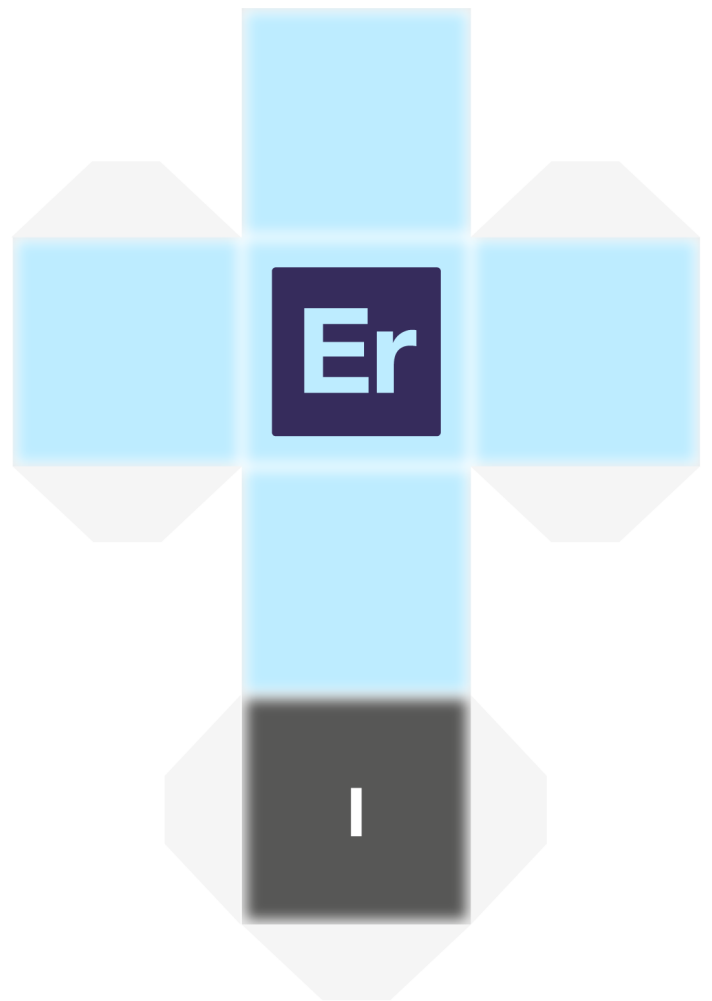
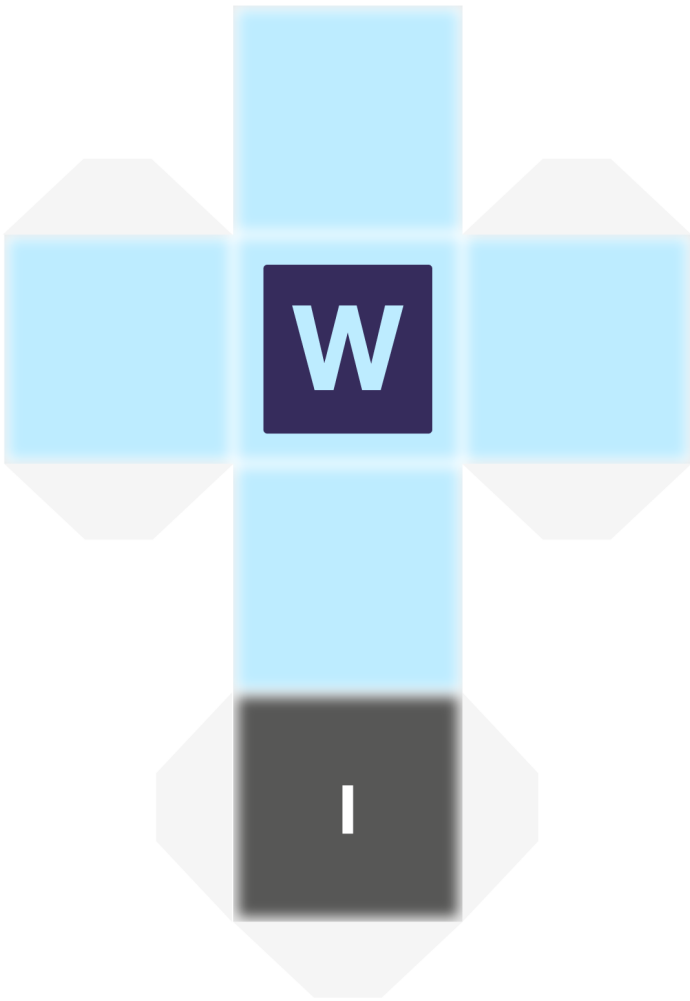

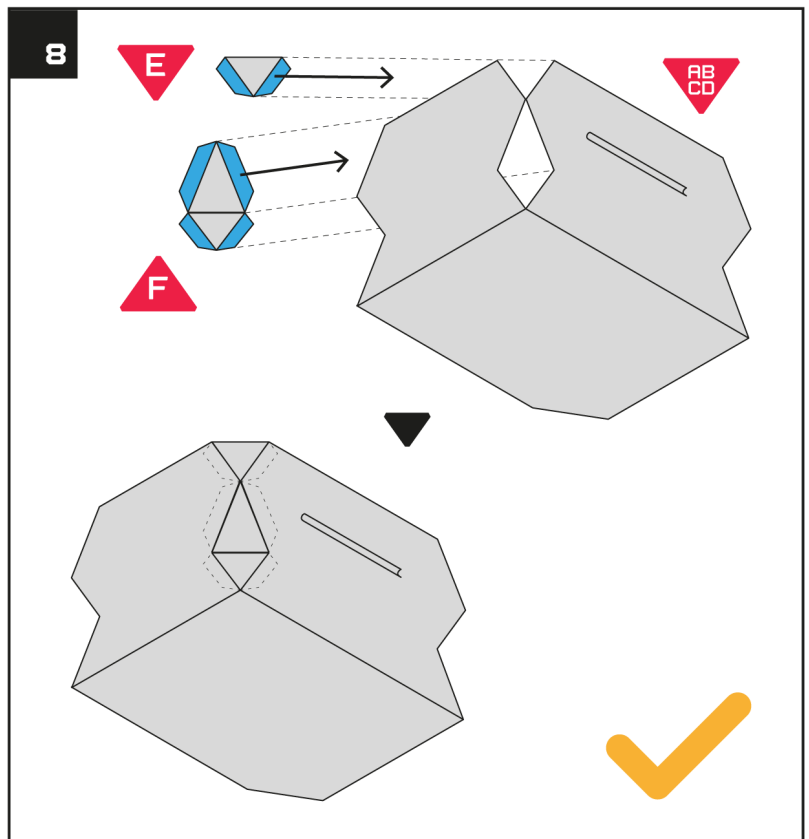
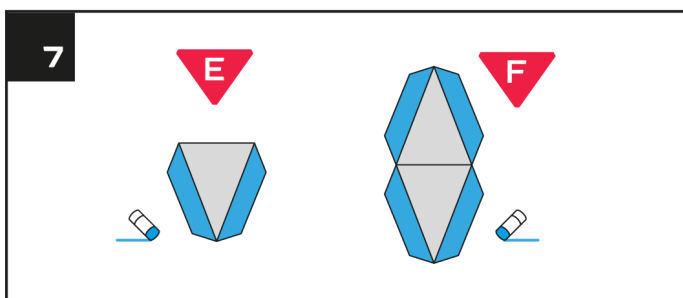
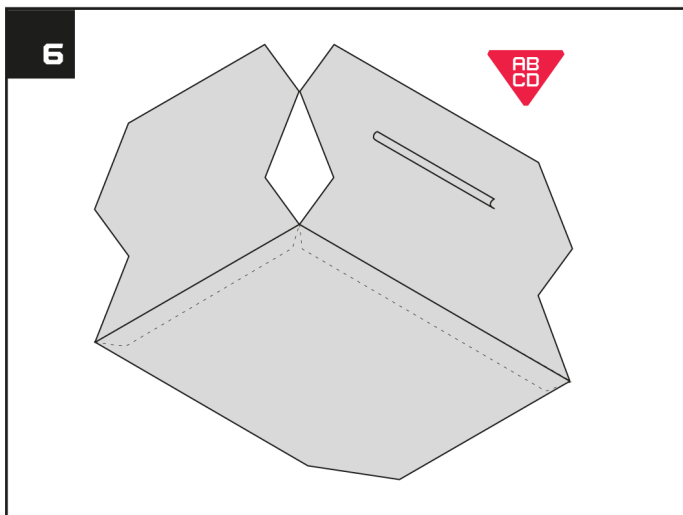
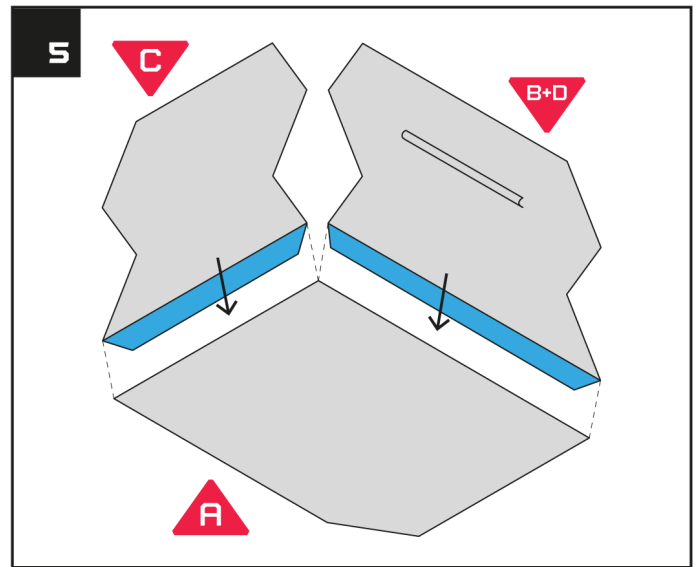
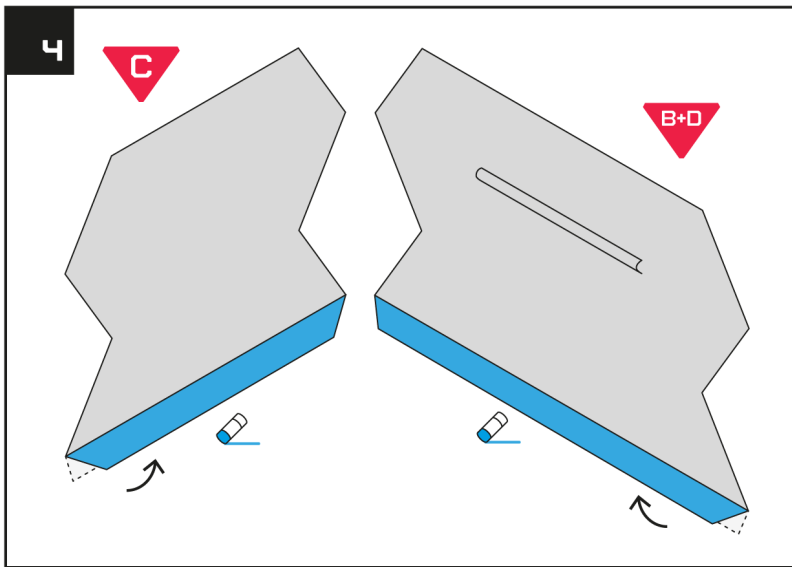
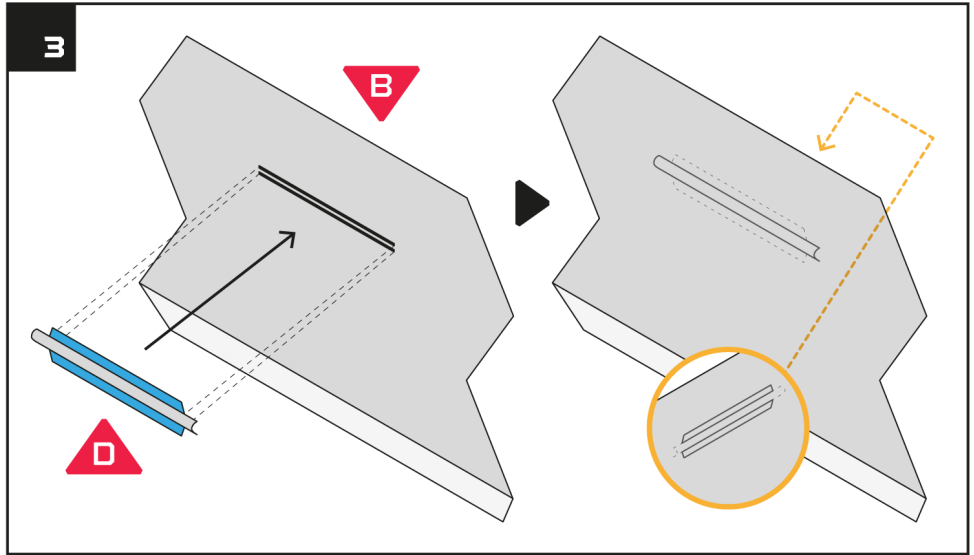
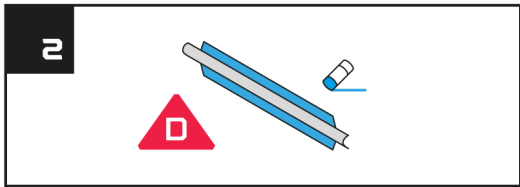
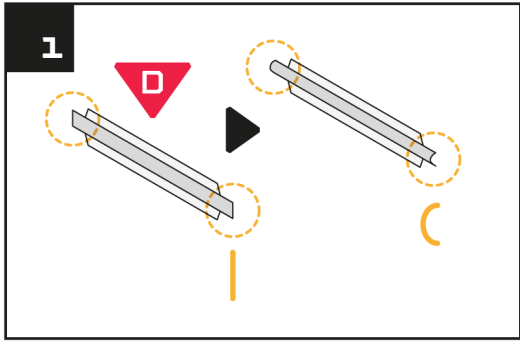

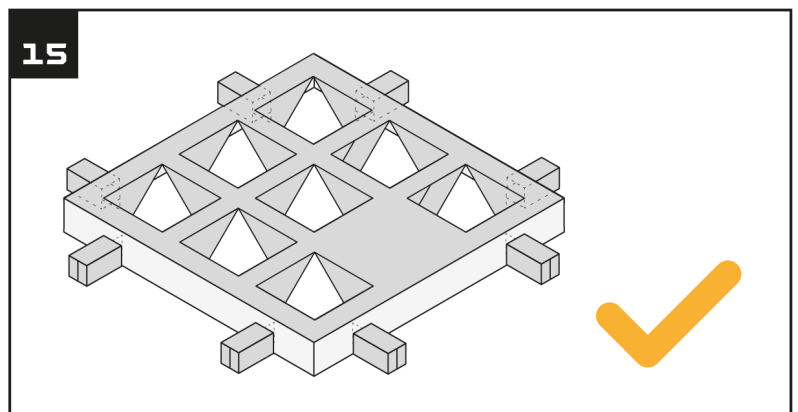
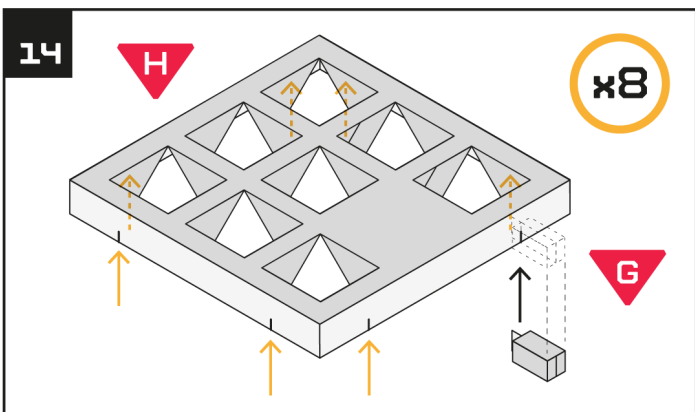
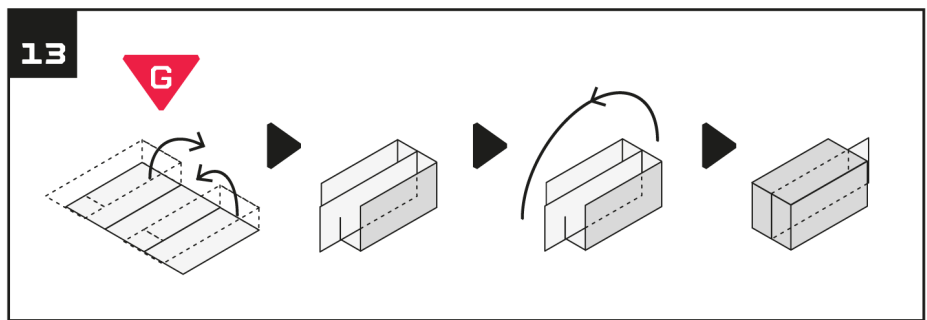
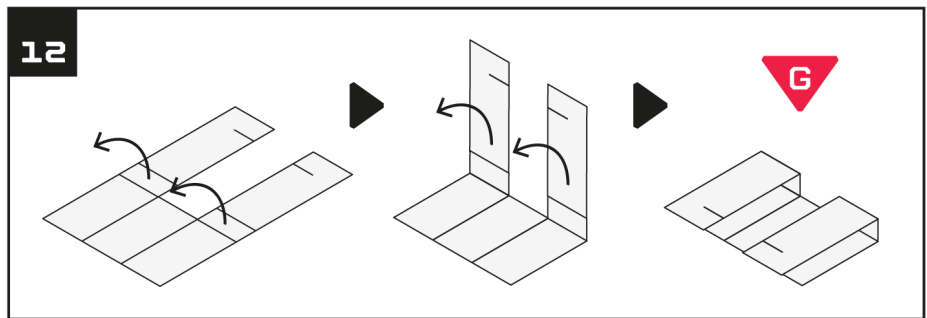
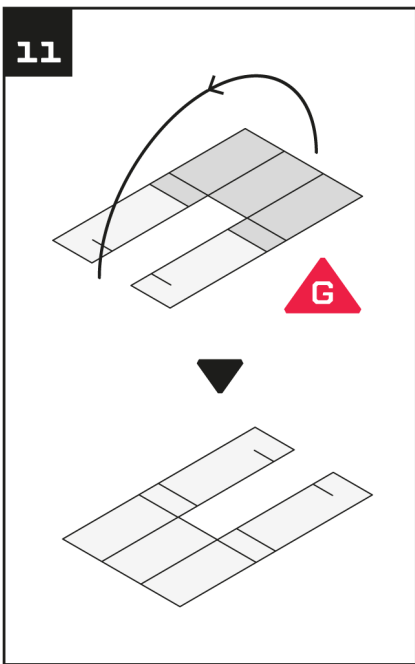
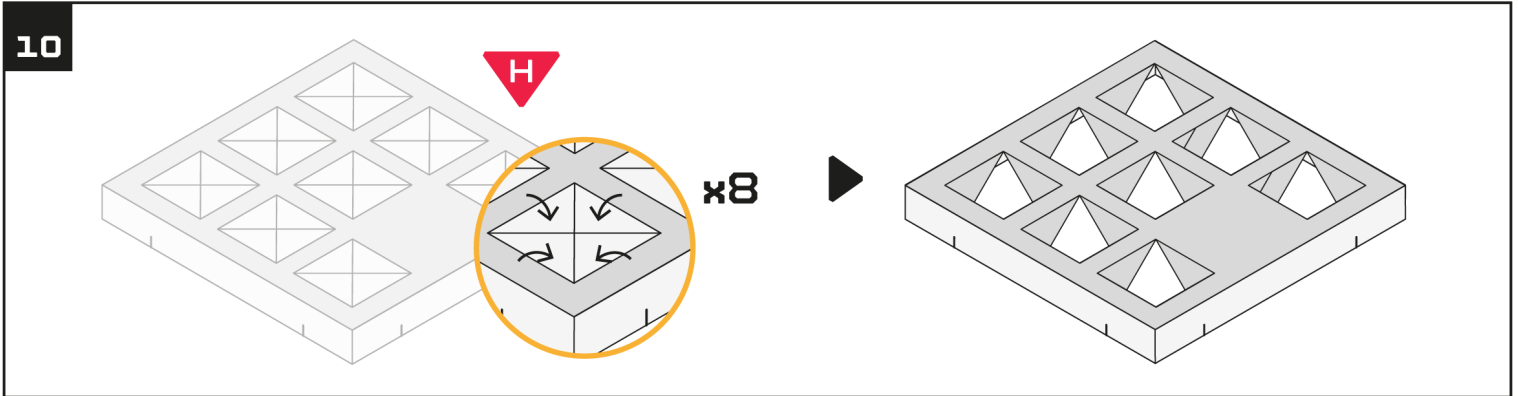
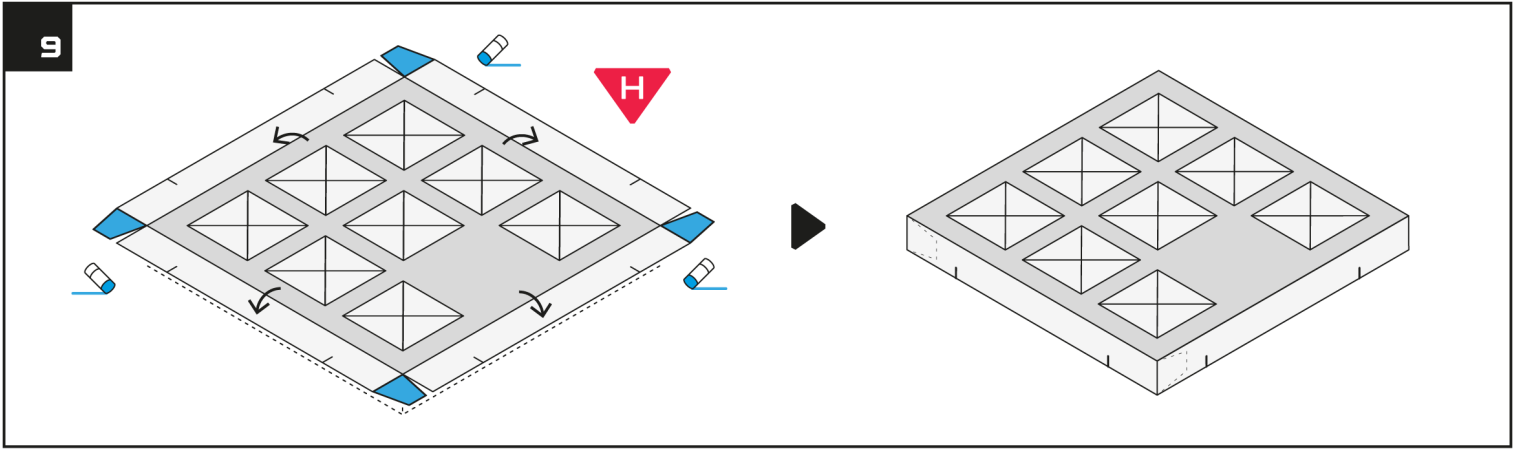

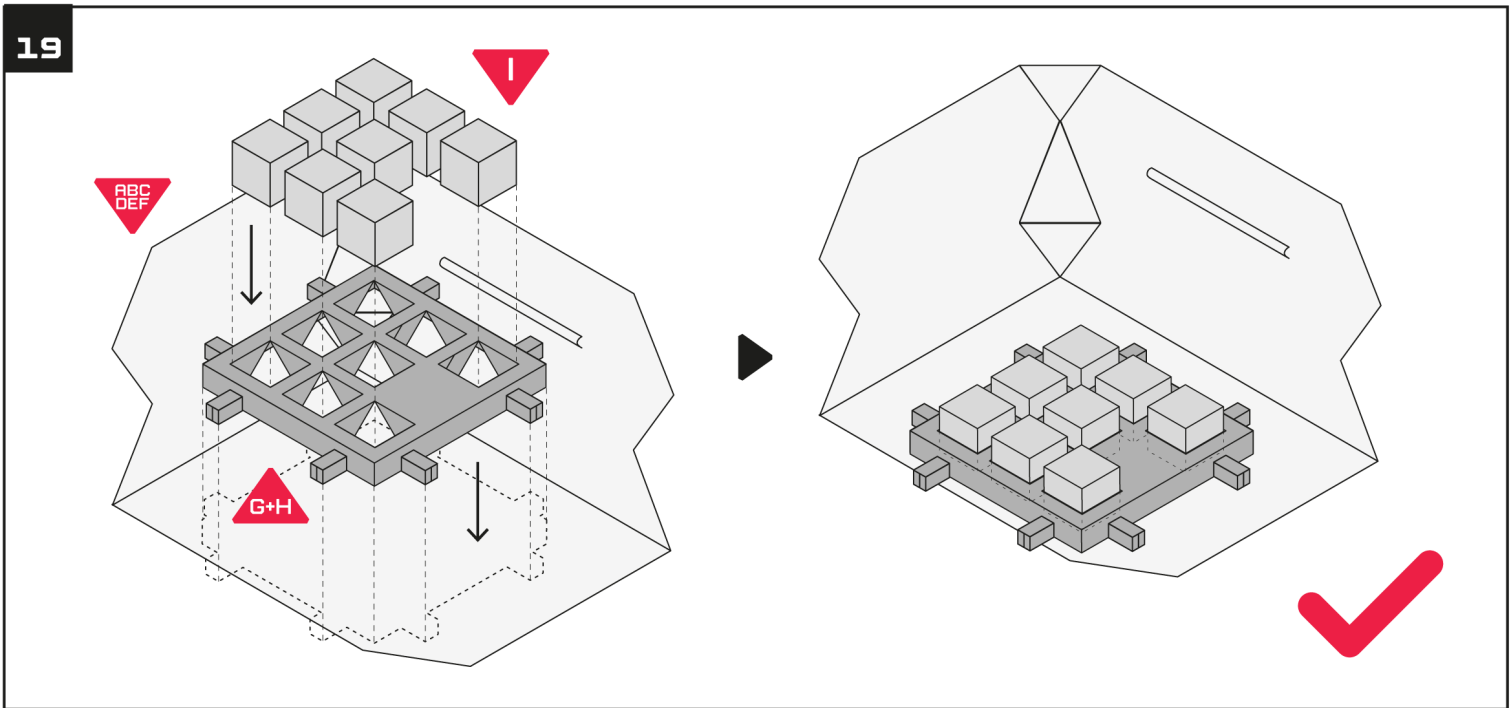
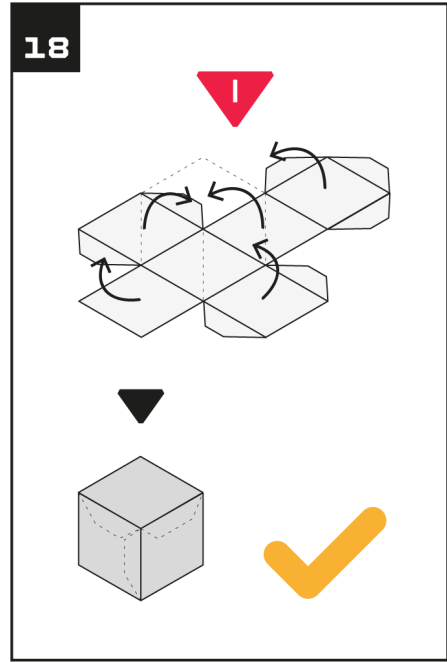
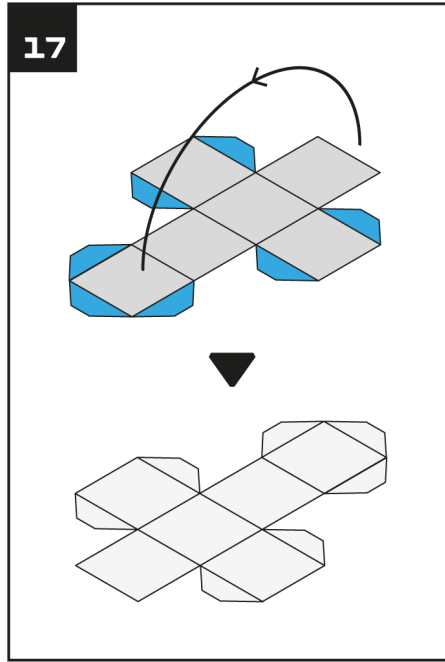
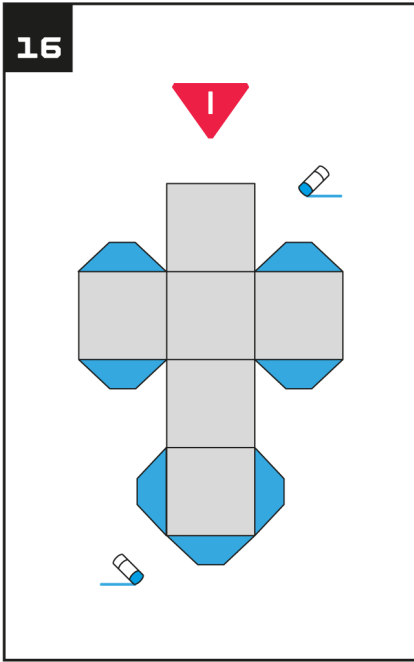

TIME FOR THE CHALLENGE

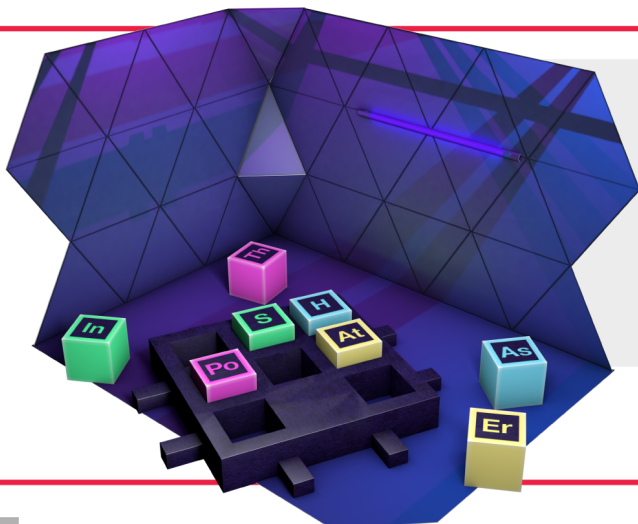

REARRANGE THE EIGHT CHEMICAL ELEMENTS TO FORM A COMPLETE CROSSWORD.

**ALSO PLAY AGAIN:
WITH MORE ELEMENTS (NEXT PAGE)**

CHECK YOUR SOLUTIONS ON

14

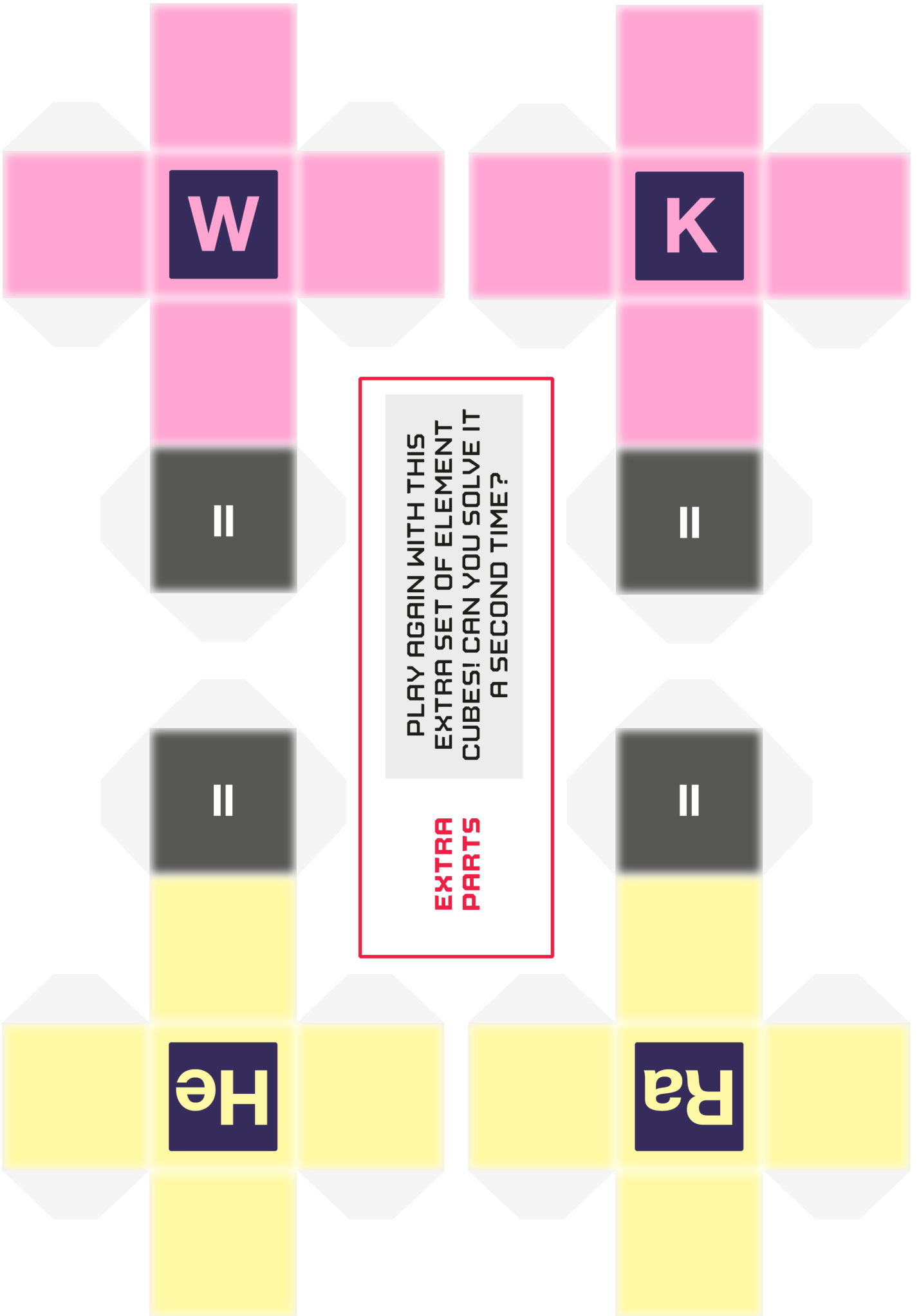

PLAY AGAIN WITH THIS
EXTRA SET OF ELEMENT
CUBES! CAN YOU SOLVE IT
A SECOND TIME?

**EXTRA
PARTS**

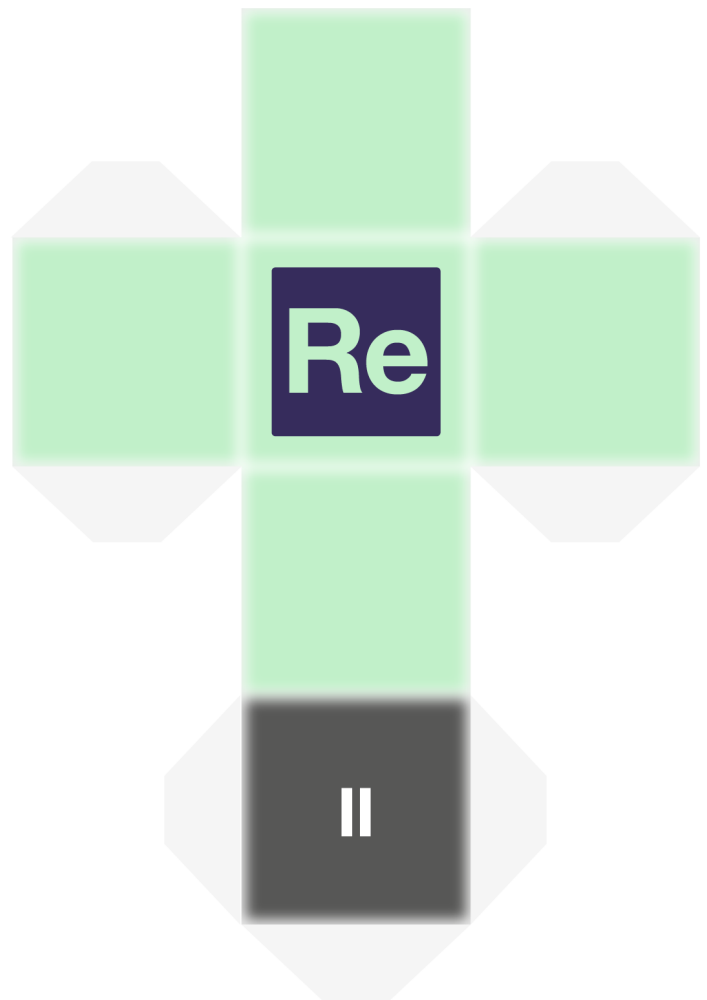
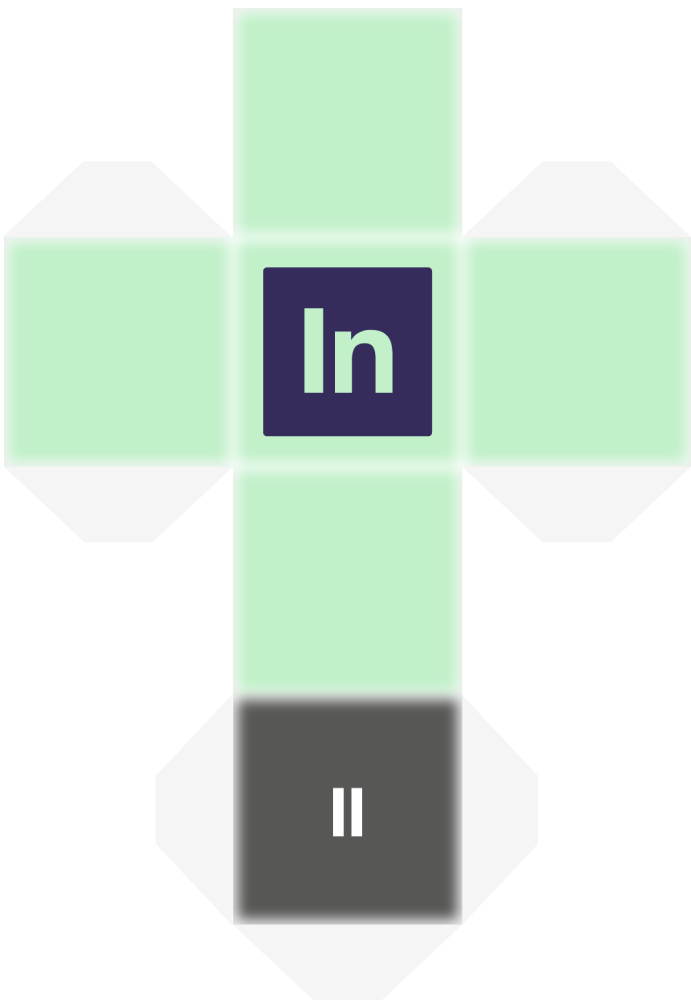
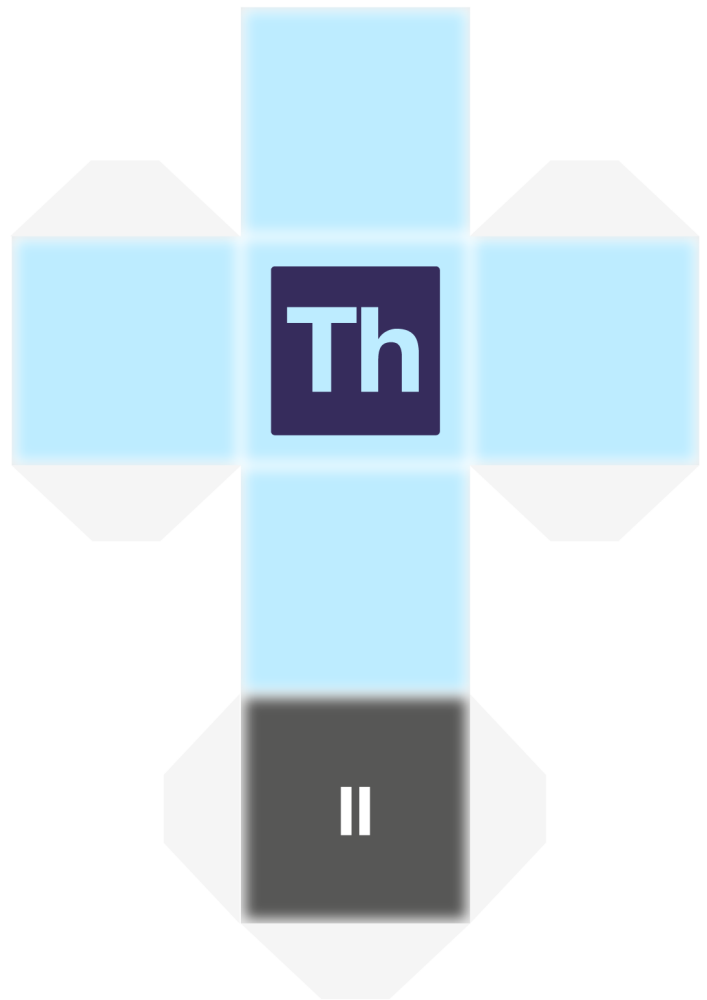
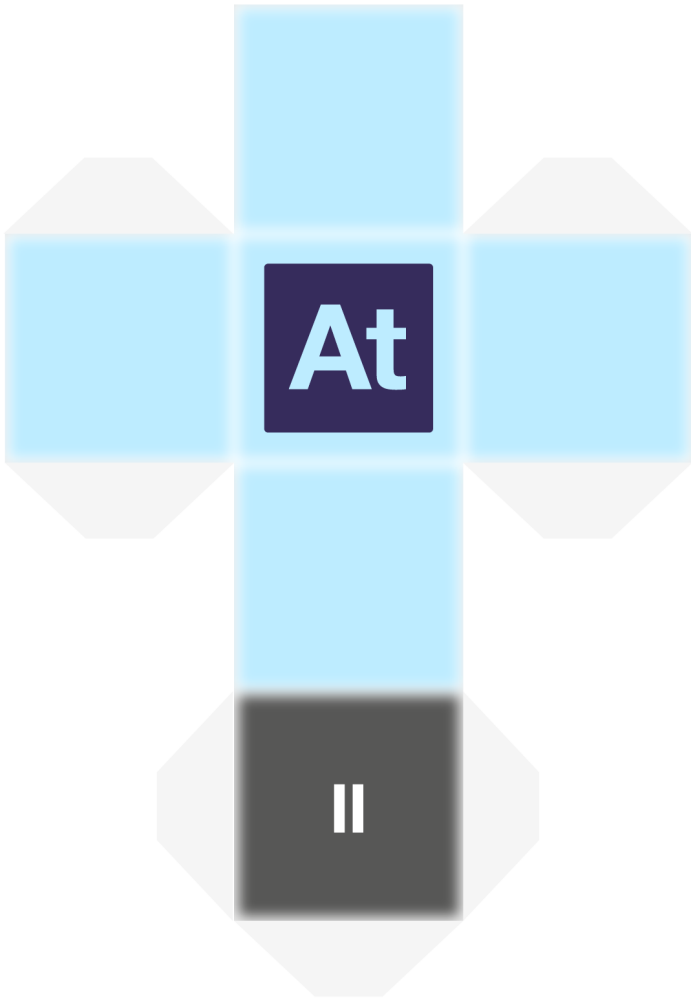

I hope you enjoyed this free puzzle!

This is a totally new style of game for me, so I'd love to know if you enjoyed this (or not!).

If you enjoyed this The Last Pyramid challenge you can find many more like it in The Last Pyramid : Adventure Puzzle Book, along with the Stop The Clock puzzle solving card game - there's lots more Last Pyramid coming soon too!

Also if you'd like to share your finished creations you can find Ultimate Quest on social media (on instagram @uqpuzzles)!

Thanks again,
Charlie :)

SOLUTIONS

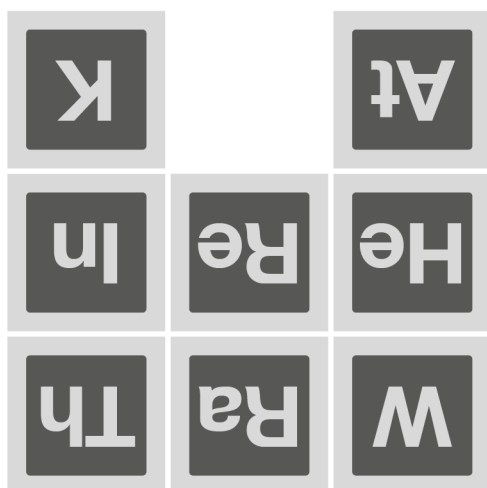

Puzzle II

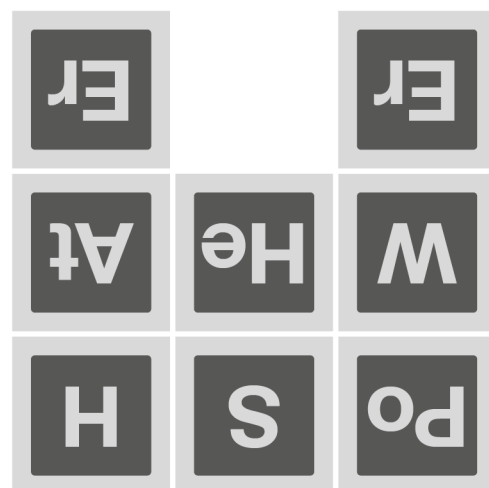

Puzzle I